

AGREEMENT FOR PURCHASE AND SALE OF GOODS

Bid/Proposal No. 021-13

Contract No. 13-00038

Project Name Solid Waste Refuse Containers

THIS AGREEMENT FOR PURCHASE AND SALE OF GOODS (the "Agreement") is made this 15th day of May, 2013, by and between IES Sales and Service, LLC, whose address is 2340 NW 147th Street, Bay F-3; Opa Locka, Florida 33054 ("Seller") and THE CITY OF NAPLES, a Florida municipal corporation, the address of which is 735 Eighth Street South, Naples, Florida 34102 ("Buyer"). In consideration of the mutual covenants and agreements hereinafter set forth herein, and for other good and valuable consideration, the receipt and sufficiency of which are hereby mutually acknowledged, Buyer and Seller agree as follows:

1. **Description of Goods; Sale and Delivery.** Seller shall sell, transfer, and deliver to Buyer the goods described on the Description/Proposal attached hereto and made a part of as **EXHIBIT A** subject to such terms as are set forth in the Description/Proposal and in this Agreement.
2. **Acceptance; Purchase.** Buyer shall accept the goods and pay for the goods in accordance with the terms of this Agreement and as indicated in **EXHIBIT B**.
3. **Identification of Goods.** Identification of the goods shall not be deemed to have been made until both Buyer and Seller have agreed that the goods in question are to be appropriate to the performance of this Agreement.
4. **Rate and Time of Payment.** Unless otherwise specified, Buyer shall make payment to Seller for the goods within 30 days after the goods are received by Buyer.
5. **Receipt of Goods.** The goods shall be deemed received by Buyer when delivered to Buyer at City of Naples, Attention: Solid Waste Division; 50 Riverside Circle; Naples, Florida 34102. Delivery of the goods to Buyer shall occur on a business day and shall not occur after 3:15 p.m. on the delivery day.
6. **Risk of Loss.** The risk of loss from any casualty to the goods, regardless of the cause, shall be on Seller up to the time of receipt of the goods by Buyer at the place of delivery, but only after any proper inspection has been completed without rejection of the goods. Thereafter, such risk shall be on Buyer, including any goods thereafter returned to Seller until their receipt by Seller.
7. **Warranty Against Encumbrances.** Seller warrants that the goods are now free, and at the time of delivery shall be free, from any security interest or other lien or encumbrance.
8. **Warranty of Title.** Seller warrants that at the time of signing this Agreement, Seller neither knows, nor has reason to know, of the existence of any outstanding title or claim of title hostile to the rights of Seller in the goods.
9. **Product Warranty.** Seller provides general warranties of fitness and general warranties that the goods are free from defects, for 1 year from acceptance of the goods, except as may otherwise be set forth in the Description/Proposal, or other attached warranty.

10. **Right of Inspection.** Buyer shall have the right to inspect the goods at the time and place of delivery, and within 5 business days after delivery, Buyer must give notice to Seller of any claim for damages on account of the condition, quality, or grade of the goods, and Buyer must specify in detail the basis of such claim. The failure of Buyer to comply with these conditions shall constitute irrevocable acceptance of the goods by Buyer.

11. **Procedure as to Rejected Goods.** On receipt of notification of rejection, Seller will immediately arrange to receive back the goods for shipment and return. However, within 5 days, Seller may have an agent inspect such goods for nonconformity; otherwise, such inspection will be made on return to Seller's storage facility. When such goods are confirmed or acquiesced in as nonconforming, Seller will ship conforming goods within 30 days of the notice of rejection unless Buyer earlier notifies Seller to forgo such shipment.

12. **Governing Law.** The parties acknowledge that the transaction that is the subject matter of this Agreement bears a reasonable relation to the State of Florida and agree that the law of the State of Florida will govern their rights and duties. The parties specifically intend that the provisions of Article 2 of the Florida Uniform Commercial Code will control as to all aspects of this Agreement and its interpretation, and that all the definitions contained therein will be applicable to this Agreement except where this Agreement may expressly provide otherwise.

13. **Bid Documents.** The terms and conditions of the Invitation to Bid, ITB 021-13 attached, Exhibit A-1, hereto and made a part hereof shall be incorporated herein as a part of this Agreement.

14. **Notices and Address of Record.** All notices required or made pursuant to this Agreement to be given by Seller to Buyer shall be in writing and shall be delivered by overnight courier, by hand or by United States Postal Service Department, first class mail service, postage prepaid, return receipt requested, addressed to the following:

To Buyer:

City of Naples
735 Eighth Street South
Naples, Florida 34102-3796
Attention: A. William Moss, City Manager

All notices required or made pursuant to this Agreement to be given by Buyer to Seller shall be made in writing and shall be delivered by overnight courier, by hand or by the United States Postal Service Department, first class mail service, postage prepaid, return receipt requested, addressed to the following:

To Seller:

IES Sales and Service, LLC
2340 NW 147 Street, Bay F-3
Opa Locka, Florida 33054
Attention: Osniel Sanchez, President
Federal Identification Number: 264241714

Either party may change its address of record by written notice to the other party given in accordance with requirements of this Article.

15. **Counterparts.** This Agreement may be executed in any number of counterparts, each of which shall be deemed to be an original as against any party whose signature appears thereon and all of which shall together constitute one and the same instrument.

16. **Effective Date.** This Agreement shall be valid through September 30, 2014 with the City's option for two (2) additional one-year (1) renewals.

IN WITNESS WHEREOF, the parties hereto have executed this Agreement on the day first written above.

ATTEST:

Yordanis Tarrayo
Tarrayo

(Print Name: OSNIEL SANCHEZ)

SELLER:

IES Sales and Service, LLC
2340 NW 147 Street, Bay F-3
Opa Locka, Florida 33054
Attention: Osniel Sanchez, President
Federal Identification Number: 264241714

By:



Authorized Representative

(Corporate Seal)

ATTEST:

By: *Patricia L. Rambosk*
Patricia L. Rambosk, City Clerk

Approved as to form and legal sufficiency:

By: *Robert D. Pritt*
Robert D. Pritt, City Attorney

BUYER

City of Naples, Florida

By:

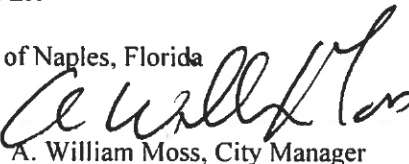

A. William Moss, City Manager

City of Naples



INVITATION TO BID
CITY OF NAPLES
PURCHASING DIVISION
CITY HALL, 735 8TH STREET SOUTH
NAPLES, FL 34102

PH: 239-213-7100 FX: 239-213-7105

| | | | |
|---|---|---|---|
| NOTIFICATION DATE: 02/01/13 | TITLE Solid Waste Refuse Containers | NUMBER: 021-13 | OPENING DATE & TIME: 02/19/13 2:00 PM |
| PRE-BID DATE, TIME AND LOCATION: N/A | | | |
| NAME OF PARTNERSHIP, CORPORATION OR INDIVIDUAL: IES SALES and Service LLC | | | |
| MAILING ADDRESS: 2340 NW 147 ST Bay F-3 | | | |
| CITY-STATE-ZIP: OPA LOCKA, FL 33054 | | | |
| PH: 305 687 9400 | | EMAIL: RECYCLE IES@GMAIL.COM | |
| FX: 305 687 9700 | | WEB ADDRESS: WWW.TRE FUSR WASTEQUIP.COM | |
| AUTHORIZED SIGNATURE | DATE 2/18/13 | PRINTED NAME/TITLE Oswin L Sanchez, President | |
| I certify that this bid is made without prior understanding, agreement, or connection with any corporation, firm, or person submitting a bid for the same materials, supplies, or equipment and is in all respects fair and without collusion or fraud. I agree to abide by all conditions of this bid and certify that I am authorized to sign this bid for the bidder. In submitting a bid to the City of Naples the bidder offers and agrees that if the bid is accepted, the bidder will convey, sell, assign or transfer to the City of Naples all rights, title, and interest in and to all causes of action it may now or hereafter acquire under the Anti-trust laws of the United States and the State of FL for price fixing relating to the particular commodities or services purchased or acquired by the City of Naples. At the City's discretion, such assignment shall be made and become effective at the time the City tenders final payment to the bidder. | | | |
| Please initial by all that apply I acknowledge receipt of the following addendum Addendum #1 05 Addendum #2 05 Addendum #3 _____ Addendum #4 _____ | | | |

PLEASE NOTE THE FOLLOWING:

- > This page **must be completed and returned** with your bid.
- > Bids must be **submitted in a sealed envelope, marked with bid number & closing date.**
- > Bids received after the above closing date and time will not be accepted.
- > **If you do not have an email address** and you want a copy of the Bid Tab, please enclose a stamped, self-addressed envelope with your bid.

GENERAL CONDITIONS

TO INSURE ACCEPTANCE OF THE BID, PLEASE FOLLOW THESE INSTRUCTIONS. ANY AND ALL SPECIAL CONDITIONS, ATTACHED HERETO, HAVE PRECEDENCE.

1. **SEALED BID:** All bids must be submitted in a sealed envelope. The face of the envelope shall contain the bid name and bid number. Bids not submitted on attached bid form shall be rejected. All bids are subject to the conditions specified herein. Those which do not comply with these conditions are subject to rejection.
2. **EXECUTION OF BID:** Bid must contain a manual signature of authorized representative in the proposal section. Bid must be typed or printed in ink. Use of erasable ink is not permitted. All corrections made by bidder to his bid must be initialed.
3. **NO BID:** If not submitting a bid, respond by returning the Statement of No Bid and explain the reason in the spaces provided. Failure to respond 3 times in succession without justification shall be cause for removal of the supplier's name from the bid mailing list. NOTE: To qualify as a respondent, bidder must submit a "NO BID," and it must be received no later than the stated bid opening date and hour.
4. **BID OPENING:** Shall be public, on the date and at the time specified on the bid form. It is the bidder's responsibility to assure that his bid is delivered at the proper time and place of the bid opening. Bids which for any reason are not so delivered will not be considered. Offers by telegram; telephone; or fax are not acceptable. Bid files may be examined during normal working hours.
5. **WITHDRAWAL OF BIDS:** Withdrawal of a bid within sixty (60) days after the opening of bids is subject to suspension or debarment in accordance with Section 2-668 of the City Code for up to three years.
6. **PRICES, TERMS and PAYMENT:** Firm Prices include all packing, handling, shipping charges and delivery to the destination shown herein. Bidder is encouraged to offer cash discount for prompt invoice payment. Terms of less than 20 days will not be considered.
 - A. **TAXES:** The City of Naples does not pay Federal Excise and Sales taxes on direct purchases of tangible personal property. See exemption number on face of purchase order. This exemption does not apply to purchases of tangible personal property made by contractors who use the tangible personal property in the performance of contracts for the improvement of City-owned real property.
 - B. **MISTAKES:** Bidders are expected to examine the specifications, delivery schedule, bid prices, extensions, and all instructions pertaining to supplies and services. Failure to do so will be at bidder's risk. In case of mistake in extension, the unit price will govern.
 - C. **CONDITION AND PACKAGING:** It is understood and agreed that any item offered or shipped as a result of this bid shall be a new, current standard production model available at the time of this bid. All containers shall be suitable for storage or shipment, and all prices shall include standard commercial packaging.
 - D. **SAFETY STANDARDS:** Unless otherwise stipulated in the bid, all manufactured items and fabricated assemblies shall comply with applicable requirements of Occupational Safety and Health Act and any standards there under.
 - E. **UNDERWRITERS' LABORATORIES:** Unless otherwise stipulated in the bid, all manufactured items and fabricated assemblies shall carry U.L. approval and re-examination listing where such has been established.
 - F. **PAYMENT:** Payment will be made by the buyer after the items awarded to a vendor have been received, inspected, and found to comply with award specifications, free of damage or defect and properly invoiced. All invoices shall bear the purchase order number. Payment for partial shipments shall not be made unless specified in the bid. Failure to follow these instructions may result in delay in processing invoices for payment. In addition, the purchase order number must appear on bills of lading, packages, cases, delivery lists and correspondence.
7. **DELIVERY:** Unless actual date of delivery is specified (or if specified delivery cannot be met), show number of days required to make delivery after receipt of purchase order in space provided. Delivery time may become a basis for making an award (see Special Conditions). Delivery shall be within the normal working hours of the user, Monday through Friday, unless otherwise specified.

8. MANUFACTURERS' NAMES AND APPROVED EQUIVALENTS: Any manufacturers' names, trade names, brand names, information and/or catalog numbers listed in a specification are for information and not intended to limit competition. The bidder may offer any brand for which he is an authorized representative, which meets or exceeds the specification for any item(s). If bids are based on equivalent products, indicate on the bid form the manufacturer's name and number. Bidder shall submit with his proposal, cuts, sketches, and descriptive literature, and/or complete specifications. Reference to literature submitted with a previous bid will not satisfy this provision. The bidder shall also explain in detail the reason(s) why the proposed equivalent will meet the specifications and not be considered an exception thereto. Bids which do not comply with these requirements are subject to rejection. Bids lacking any written indication of intent to quote an alternate brand will be received and considered in complete compliance with the specifications as listed on the bid form.

9. INTERPRETATIONS: Any questions concerning conditions and specifications shall be directed in writing to this office for receipt no later than ten (10) days prior to the bid opening. Inquiries must reference the date of bid opening and bid number. Failure to comply with this condition will result in bidder waiving his right to dispute the bid.

10. CONFLICT OF INTEREST: All bid awards are subject to Section 2-973 Conflict of Interest, City of Naples Code of Ordinances, which states: *"No public officer or employee shall have or hold any employment or contractual relationship with any business entity or any agency which is subject to the regulation of or is doing business with the city; nor shall an officer or employee have or hold any employment or contractual relationship that will create a continuing or frequently recurring conflict between his private interests and the performance of his public duties or that would impede the full and faithful discharge of his public duties. Any member of the city council or any city officer or employee who willfully violates this section shall be guilty of malfeasance in office or position and shall forfeit his office or position. Violation of this section with the knowledge, express or implied, of the person or corporation contracting with or making a sale to the city shall render the contract or sale voidable by the city manager or the city council."*

11. AWARDS: As the best interest of the City may require, the right is reserved to make award(s) by individual item, group of items, all or none, or a combination thereof; to reject any and all bids or waive any minor irregularity or technicality in bids received.

12. ADDITIONAL QUANTITIES: For a period not exceeding ninety (90) days from the date of acceptance of this offer by the buyer, the right is reserved to acquire additional quantities up to but not exceeding those shown on bid at the prices bid in this invitation. If additional quantities are not acceptable, the bid sheets must be noted "BID IS FOR SPECIFIED QUANTITY ONLY." (THIS PARAGRAPH DOES NOT APPLY FOR A TERM CONTRACT.)

13. SERVICE AND WARRANTY: Unless otherwise specified, the bidder shall define any warranty service and replacements that will be provided during and subsequent to this contract. Bidders must explain on an attached sheet to what extent warranty and service facilities are provided.

SAMPLES: Samples of items, when called for, must be furnished free of expense, on or before bid opening time and date, and if not destroyed may, upon request, be returned at the bidder's expense. Each individual sample must be labeled with bidder's name, manufacturer's brand name and number, bid number and item reference. Request for return of samples shall be accompanied by instructions which include shipping authorization and name of carrier and must be received with your bid. If instructions are not received within this time, the commodities shall be disposed of by the City of Naples.

BID PROTEST: The city has formal bid protest procedures that are available on request.

16. INSPECTION, ACCEPTANCE AND TITLE: Inspection and acceptance will be at destination unless otherwise provided. Title and risk of loss or damage to all items shall be the responsibility of the contract supplier until accepted by the ordering agency, unless loss or damage results from negligence by the ordering

17. DISPUTES: In case of any doubt or difference of opinion as to the items to be furnished hereunder, the decision of the buyer shall be final and binding on both parties.

18. GOVERNMENTAL RESTRICTIONS: In the event any governmental restrictions may be imposed which would necessitate alteration of the material, quality, workmanship or performance of the items offered on this proposal prior to their delivery, it shall be the responsibility of the successful bidder to notify the buyer at once, indicating in his letter the specific regulation which required an alteration. The City reserves the right to accept any such alteration, including any price adjustments occasioned thereby, or to cancel the contract at no expense to the City.

19. LEGAL REQUIREMENTS: Applicable provision of all Federal, State, county and local laws, and of all ordinances, rules, and regulations shall govern development submittal and evaluation of all bids received in response hereto and shall govern any and all claims and disputes which may arise between person(s) submitting a bid response hereto and the City of Naples by and through its officers, employees and authorized representatives, or any other person, natural or otherwise; and lack of knowledge by any bidder shall not constitute a cognizable defense against the legal effect thereof.

20. PATENTS AND ROYALTIES: The bidder, without exception, shall indemnify and save harmless the City of Naples and its employees from liability of any nature or kind, including cost and expenses for or on account of any copyrighted, patented, or unpatented invention, process, or article manufactured or used in the performance of the contract, including its use by the City of Naples. If the bidder uses any design, device, or materials covered by letters, patent or copyright, it is mutually agreed and understood without exception that the bid prices shall include all royalties or cost arising from the use of such design, device, or materials in any way involved in the work.

21. ADVERTISING: In submitting a bid, bidder agrees not to use the results there from as a part of any commercial advertising.

22. ASSIGNMENT: Any Purchase Order issued pursuant to this bid invitation and the monies which may become due hereunder are not assignable except with the prior written approval of the buyer.

23. LIABILITY: The supplier shall hold and save the City of Naples, its officers, agents, and employees harmless from liability of any kind in the performance of this contract.

24. PUBLIC ENTITY CRIMES: A person or affiliate who has been placed on the convicted vendor list following a conviction for a public entity crime may not submit a bid on a contract to provide any goods or services to a public entity, may not submit a bid on a contract with a public entity for the construction or repair of a public building or public work, may not submit bids on leases of real property to a public entity, may not be awarded or perform work as a contractor, supplier, subcontractor, or consultant under a contract with any public entity, and may not transact business with any public entity in excess of the threshold amount provided in Section 287.017, for CATEGORY TWO for a period of 36 months from the date of being placed on the convicted vendor list.

25. DISCRIMINATION: An entity or affiliate who has been placed on the discriminatory vendor list may not submit a bid on a contract to provide goods or services to a public entity, may not submit a bid on a contract with a public entity for the construction or repair of a public building or public work, may not submit bids on leases of real property to a public entity, may not award or perform work as a contractor, supplier, subcontractor, or consultant under contract with any public entity, and may not transact business with any public entity.

26. COUNTY TAXES: No proposal shall be accepted from and no contract will be awarded to any person, firm or corporation that is in arrears to the government of Collier County, Florida.

27. OFFER EXTENDED TO OTHER GOVERNMENTAL ENTITIES: The City of Naples encourages and agrees to the successful bidder/proposer extending the pricing, terms and conditions of this solicitation or resultant contract to other governmental entities at the discretion of the successful bidder/proposer.

IF THIS BID IS FOR A TERM CONTRACT, THE FOLLOWING CONDITIONS SHALL ALSO APPLY

28. ELIGIBLE USERS: All departments of the City of Naples are eligible to use this term contract. Such purchases shall be exempt from the competitive bid requirements otherwise applying to their purchases.

29. PRICE ADJUSTMENTS: Any price decrease effectuated during the contract period by reason of market change shall be passed on to City of Naples. Price increases are not acceptable.

30. CANCELLATION: All contract obligations shall prevail for at least one hundred eighty (180) days after effective date of contract. After that period, for the protection of both parties, this contract may be cancelled in whole or in part by either party by giving thirty (30) days prior written notice to the other party.

31. RENEWAL: The City of Naples reserves the option to renew the period of this contract, or any portion thereof for up to two (2) additional periods. Renewal of the contract period shall be by mutual agreement in writing.

32. ABNORMAL QUANTITIES: While it is not anticipated, should any unusual or abnormal requirements arise, the City reserves the right to solicit separate bids thereon.

33. FISCAL NON-FUNDING CLAUSE: In the event sufficient funds are not budgeted for a new fiscal period, the City shall notify the contractor of such occurrence and the contract shall terminate on the last day of the current fiscal year without penalty or expense to the City.

IF THIS BID IS FOR PERFORMING A SERVICE, THE FOLLOWING CONDITIONS SHALL ALSO APPLY

34. ALTERNATIVE BIDS: Bidders offering service delivery methods other than those permitted by the scope of work may submit a separate envelope clearly marked "ALTERNATIVE BID". Alternative bids will be deemed non-responsive and will not be considered for award. All such responses will, however, be examined prior to award. Such examination may result in cancellation of all bids received to permit rewriting the scope of work to include the alternative method, or the alternative method may be considered for future requirements of the City of Naples.

35. ANTITRUST: By entering into a contract, the contractor conveys, sells, assigns and transfers to the City of Naples all rights, titles and interest it may now have or hereafter acquire under the antitrust laws of the United States and the State of Florida that relate to the particular goods or services purchased or acquired by the City of Naples under said contract.

36. BIDDER INVESTIGATIONS: Before submitting a bid, each bidder shall make all investigations and examinations necessary to ascertain all site conditions and requirements affecting the full performance of the contract and to verify any representations made by the City of Naples upon which the bidder will rely. If the bidder receives an award as a result of its bid submission, failure to have made such investigations and examinations will in no way relieve the bidder from its obligation to comply in every detail with all provisions and requirements of the contract documents, nor will a plea of ignorance of such conditions and requirements be accepted as a basis for any claim whatsoever by the contractor for additional compensation.

37. CERTIFICATES AND LICENSES: The Contractor, at time of proposal, shall possess the correct occupational licenses, all professional licenses or other authorizations necessary to carry out and perform the work required by the City of Naples and Collier County for this project pursuant to all applicable Federal, State and Local Laws, Statues, Ordinances, and rules and regulations of any kind.

38. CHANGE IN SCOPE OF WORK: The City of Naples may order changes in the work consisting of additions, deletions or other revisions within the general scope of the contract. No claims may be made by the contractor that the scope of the project or of the contractor's services has been changed, requiring changes to the amount of compensation to the contractor or other adjustments to the contract unless such changes or adjustments have been made by written amendment to the contract signed by the City of Naples and the contractor. If the contractor believes that any particular work is not within the scope of the project, is a material change, or will otherwise require more compensation to the contractor, the contractor must immediately notify the City in writing of this belief. If the City believes that the particular work is within the scope of the contract

as written, the contractor will be ordered to and shall continue with the work as changed and at the cost stated for the work within the scope.

39. CONTRACTOR PERSONNEL: The City of Naples shall, throughout the life of the contract, have the right of reasonable rejection and approval of staff or subcontractors assigned to the work by the contractor. If the City reasonably rejects staff or subcontractors, the contractor must provide replacement staff or subcontractors satisfactory to the City in a timely manner and at no additional cost to the City. The day-to-day supervision and control of the contractor's employees and sub-contractors is the responsibility solely of the contractor.

40. COST REIMBURSEMENT: The contractor agrees that all incidental costs, including allowances for profit and tools of the trade, must be included in the bid proposal rates. If an arrangement is made between the contractor and the City to reimburse the contractor for the cost of materials provided in the performance of the work, the contractor shall be reimbursed in the following manner: The City shall reimburse the contractor on completion and acceptance of each assigned job, only for those materials actually used in the performance of the work that is supported by invoices issued by the suppliers of the contractor describing the quantity and cost of the materials purchased. No surcharge shall be added to the supplier's invoices or included in the contractor's invoice submitted to the City that would increase the dollar amount indicated on the supplier's invoice for the materials purchased for the assigned job.

41. EXCEPTIONS: Bidders taking exception to any part or section of the solicitation shall indicate such exceptions on the bid form. Failure to indicate any exception will be interpreted as the bidder's intent to comply fully with the requirements as written. Conditional or qualified bids, unless specifically allowed, shall be subject to rejection in whole or in part.

42. FAILURE TO DELIVER: In the event of the contractor to fail to deliver services in accordance with the contract terms and conditions, the City, after due oral or written notice, may procure the services from other sources and hold the contractor responsible for any resulting purchase and administrative costs. This remedy shall be in addition to any other remedies that the City may have.

43. FAILURE TO ENFORCE: Failure by the City at any time to enforce the provisions of the contract shall not be construed as a waiver of any such provisions. Such failure to enforce shall not affect the validity of the contract or any part thereof or the right of the City to enforce any provision at any time in accordance with its terms.

44. FORCE MAJEURE: The contractor shall not be held responsible for failure to perform the duties and responsibilities imposed by the contract due to legal strikes, fires, riots, rebellions and acts of God beyond the control of the contractor, unless otherwise specified in the contract.

45. INDEPENDENT CONTRACTOR: The contractor shall be legally considered an independent contractor and neither the contractor nor its employees shall, under any circumstances, be considered servants or agents of the City of Naples and the City of Naples shall be at no time legally responsible for any negligence or any wrongdoing by the contractor, its servants or agents. The City of Naples shall not withhold from the contract payments to the contractor any federal income taxes, Social Security tax, or any other amounts for benefits to the contractor. Further, the City shall not provide to the contractor any insurance coverage or other benefits, including Workers' Compensation normally provided by the City for its employees.

46. ORAL STATEMENTS: No oral statement of any person shall modify or otherwise affect the terms, conditions or specifications stated in this contract. All modifications to the contract must be made in writing by the City of Naples.

47. QUALIFICATIONS OF BIDDERS: The bidder may be required, before the award of any contract, to show to the complete satisfaction of the City of Naples that it has the necessary facilities, ability, and financial resources to provide the service specified therein in a satisfactory manner. The bidder may also be required to give a past history and references in order to satisfy the City in regard to the bidder's qualifications. The City may make reasonable investigations deemed necessary and proper to determine the ability of the bidder to perform the work, and the bidder shall furnish to the City all information for this purpose that may be requested. The City reserves the right to reject any bid if the evidence submitted by, or investigation of, the bidder fails to

satisfy the City that the bidder is properly qualified to carry out the obligations of the contract and to complete the work described therein. Evaluation of the bidder's qualifications shall include:

- > The ability, capacity, skill and financial resources to perform the work or service.
- > The ability to perform the work service promptly or within the time specified, without delay.
- > The character, integrity, reputation, judgment, experience, and efficiency of the bidder.
- > The quality of performance of previous contracts or services.

48. QUALITY CONTROL: The contractor shall institute and maintain throughout the contract period a properly documented quality control program designed to ensure that the services are provided at all times and in all respects in accordance with the contract. The program shall include providing daily supervision and conducting frequent inspections of the contractor's staff and ensuring that accurate records are maintained describing the disposition of all complaints. The records so created shall be open to inspection by the City.

49. RECOVERY OF MONEY: Whenever, under the contract, any sum of money shall be recoverable from or payable by the contractor to the City, the same amount may be deducted from any sum due to the contractor under the contract or under any other contract between the contractor and the City. The rights of the City are in addition and without prejudice to any other right the City may have to claim the amount of any loss or damage suffered by the City on account of the acts or omissions of the contractor.

50. REQUIREMENTS CONTRACT: During the period of the contract, the contractor shall provide all the services described in the contract. The contractor understands and agrees that this is a requirements contract and that the City shall have no obligation to the contractor if no services are required. Any quantities that are included in the scope of work reflect the current expectations of the City for the period of the contract. The amount is only an estimate and the contractor understands and agrees that the City is under no obligation to the contractor to buy any amount of services as a result of having provided this estimate or of having any typical or measurable requirement in the past. The contractor further understands and agrees that the City may require services in excess of the estimated annual contract amount and that the quantity actually used whether in excess of, or less than, the estimated annual contract amount and that the quantity actually used shall not give rise to any claim for compensation other than the total of the unit prices in the contract for the quantity actually used.

51. TERMINATION FOR CONVENIENCE: The performance of work under the contract may be terminated by the City in whole or in part whenever the City determines that termination is in the City's best interest. Any such termination shall be effected by the delivery to the contractor of a written notice of termination of at least seven (7) days before the date of termination, specifying the extent to which performance of the work under the contract is terminated and the date upon which such termination becomes effective. After receipt of a notice of termination, except as otherwise directed, the contractor shall stop work on the date of the receipt of the notice or other date specified in the notice; place no further orders or subcontracts for materials, services or facilities except as necessary for completion of such portion of the work not terminated; terminate all vendors and subcontracts; and settle all outstanding liabilities and claims.

52. TERMINATION FOR DEFAULT: The City of Naples reserves the right to terminate the contract if the City determines that the contractor has failed to perform satisfactorily the work required, as determined by the City. In the event the City decides to terminate the contract for failure to perform satisfactorily, the City shall give to the contractor at least seven (7) days written notice before the termination takes effect. The seven-day period will begin upon the mailing of notice by the City. If the contractor fails to cure the default within the seven (7) days specified in the notice and the contract is terminated for failure to perform satisfactorily, the contractor shall be entitled to receive compensation for all reasonable, allocable and allowable contract services satisfactorily performed by the contractor up to the date of termination that were accepted by the City prior to the termination. In the event the City terminates the contract because of the default of the contractor, the contractor shall be liable for all excess costs that the City is required to expend to complete the work under contract.

53. STATE AND FEDERAL EMPLOYMENT LAWS: Contractors providing service to the City are required to comply with all state and federal employment laws. This includes, but is not limited to, laws resulting from the Immigration and Reform and Control Act of 1986, wherein all employers are required to verify the identity and employment eligibility of all employees. The Department of Homeland Security, U.S. Citizenship and Immigration Services require employees and employers to complete Form I-9 and the employer must

examine evidence of identity and employment eligibility within three business days of the date employment begins. Non compliant contractors will be subject to contract sanctions, up to and including contract termination.

54. CERTIFICATION REGARDING DEBARMENT, SUSPENSION, INELIGIBILITY, AND VOLUNTARY EXCLUSION: The contractor agrees to comply with Executive Order 12549 "Debarment and Suspension" and 2 CFR 180 "OMB Guidelines to Agencies on Government wide Debarment and Suspension." These rules require all contractors using federal funds not be debarred or suspended from doing business with the Federal Government. This includes sub-recipients and lower tier participant for covered transactions. Signing and submitting this document certified the organization and its principals are not presently debarred, suspended, proposed for debarment, declared ineligible, or voluntarily excluded from participation in this transaction by any federal department or agency, and further have not within the preceding three-year period been convicted of or had a civil judgment rendered against them for commission of fraud or a criminal offense in connection with obtaining, attempting to obtain, or performing a public (Federal, State or local) transaction .

THE CITY OF NAPLES IS AN EQUAL OPPORTUNITY EMPLOYER

GENERAL INSURANCE REQUIREMENTS

The Contractor shall not commence work until he has obtained all the insurance required under this heading, and until such insurance has been approved by the Owner, nor shall the Contractor allow any subcontractor to commence work until all similar insurance required of the subcontractor has also been obtained and approved by the Owner.

Certificates of insurance must be issued by an authorized representative of the insurance company at the request and direction of the policyholder and must include sufficient information so as to identify the coverage and the contract for Owner's improvements for which they are issued. Certificates of insurance must be issued by a nationally recognized insurance company with a Best's Rating of no less than B+VII, satisfactory to the Owner, and duly licensed to do business in the state of said Contract.

The Contractor shall procure and maintain, during the life of this Contract, Worker's Compensation Insurance for all of his employees to be engaged in work under this Contract, and he shall require any subcontractor similarly to provide Worker's Compensation Insurance for all of the latter's employees to be engaged in such work, unless such employees are covered by the protection afforded by the Contractor's insurance. In case any employees are to be engaged in hazardous work under this Contract, and are not protected under this Worker's Compensation statute, the Contractor shall provide, and shall cause each subcontractor to provide, adequate coverage for the protection of such employees. It is acceptable to use a State-approved Worker's Compensation Self-Insurance fund.

The Contractor shall take out and maintain during the life of this Contract, Public Liability and Property Damage and shall include Contractual Liability, Personal Injury, Libel, Slander, False Arrest, Malicious Prosecution, Wrongful Entry or Eviction, Broad Form Property Damage, Products, Completed Operations and XCU Coverage to be included on an occurrence basis, and to the full extent of the Contract to protect him, the Owner, and any subcontractor performing work covered by this Contract from damages for personal injury, including accidental death, as well as from claims for property damage, which may arise from operations under this contract, whether such operations be by himself or by a subcontractor, or by anyone directly or indirectly employed by either of them. The Contractor shall also maintain automobile liability insurance including "non-owned and hired" coverage. The entire cost of this insurance shall be borne by the Contractor.

The amount of such insurance shall be no less than \$1,000,000 annual aggregate for bodily injury and property damage combined per occurrence.

The City of Naples must be named as Additional Insured on the insurance certificate and the following must also be stated on the certificate. "This coverage is primary to all other coverage the City possesses for this contract only." The City of Naples shall be named as the Certificate Holder. The Certificate Holder shall read as follows:

The City of Naples
735 Eighth Street South
Naples, Florida 34102

No City Division, Department, or individual name should appear on the Certificate.
No other format will be acceptable.

The Certificate must state the proposal number and title.

When using the "Accord"- 25 Certificate of Insurance only the most current version will be accepted.

The City of Naples requires a copy of a cancellation notice in the event the policy is cancelled. The City of Naples shall be expressly endorsed onto the policy as a cancellation notice recipient.

STATEMENT OF NO BID

If you will not be bidding on this product/service, please help us by completing and returning only this page to:

**City of Naples, Purchasing Division
City Hall, 735 8th Street South
Naples, FL 34102
Fax 239-213-7105**

Bid # _____ and Description: _____

We, the undersigned, decline to proposal on the above project for the following reason(s):

- We are not able to respond to the Invitation to Bid or Request for Proposals by the specified deadline.**
- Our Company does not offer this product or service.**
- Our current work schedule will not permit us to perform the required services.**
- Specifications are incomplete or information is unclear (Please explain below).**

Other (Please specify below)

Company Name _____ PH _____

Name and Title of individual completing this form:

(Printed Name) _____ (Title) _____

(Signature) _____ (Date) _____

REFERENCES

THIS SHEET MUST BE COMPLETED AND RETURNED WITH BID

PROVIDE AT LEAST THREE REFERENCES FOR WHOM YOUR COMPANY HAS PROVIDED SAME OR SIMILAR SERVICES WITHIN THE LAST 2 YEARS.

COMPANY NAME: City of Tampa Solid Waste
 ADDRESS: 4010 West Spruce St Tampa FL 33607
 TELEPHONE: 813-326-2684
 CONTACT PERSON: FERRY GIMBLRT
 CONTACT E-MAIL ADDRESS: ferryg@cityoftampa.fl.us

COMPANY NAME: WSI - 1ESI Progressive Waste
 ADDRESS: 3840 NW 37th Court, Miami FL 33142
 TELEPHONE: 786-402-1565
 CONTACT PERSON: ELEONOR LORENZO
 CONTACT E-MAIL ADDRESS: elorenzo@wsi.us

COMPANY NAME: Waste Management
 ADDRESS: 20701 Pembrooke Road, Pembroke Pines FL 33029
 TELEPHONE: 305-986-0214
 CONTACT PERSON: RICARDO TROURA
 CONTACT E-MAIL ADDRESS: RTROURA@wm.com

SPECIAL CONDITIONS

A. TERMS OF CONTRACT

The resulting contract will commence on award and be in effect until completion of the project.

B. PROHIBITION OF CONTACT

Under no circumstances should any prospective organization or individual, or anyone acting for or on behalf of a prospective organization or individual, seek to influence or gain the support of any member of the City Council, public official or City staff favorable to the interest of any prospective organization or individual.

Likewise, contact with City Council, any public official or city staff against the interests of other prospective organization (s) and or individual(s) is prohibited. Any such activities will result in the exclusion of the prospective organization or individual from consideration by the City.

C. REFERENCES

Bidder must submit a minimum of three references on the form provided.

D. STATEMENT OF NO BID

If you will not be bidding on this producer/service, please help us by completing and returning the Statement of No Bid.

E. BID FORMAT

The Contract, if awarded, will be awarded on the basis of material and equipment illustrated and described on the Drawings or specified in the Specification. If a substitution or an "or equal" item is proposed, Bidder must submit this information to the City of Naples Purchasing Department ten (10) days prior to the Bid Date for evaluation as an acceptable substitution or an "or equal" item. If the substitution or the "or equal" item is accepted, the City of Naples will issue an Addendum to all Bidders listing the allowable substitution or the "or equal" item. The cost of changes in related work, additional drawings which may be required to illustrate or define the substitute or "or equal" equipment and its relationship to the other parts or portions of the Work shall be paid by the Contractor. No change will be made in the amount of time in which to complete the Work or in the liquidated damages.

F. BID PERFORMANCE & PAYMENT BONDS

A Bid Security Bond shall be submitted with the final bid, if the total bid is greater than \$125,000.00, in an amount equal to at least five percent (5%) of the total amount of the final bid, or the equivalent in the form of a certified check or money order made payable to the City of Naples, Florida. Upon the award of the bid to the successful proposer, both bid performance bond and the payment bond will be required in the amount of one hundred percent (100%) of the price specified in the contract. **Also proof of insurance from the successful proposer is required at the time of award as well.**

G. QUESTIONS

Questions regarding this bidder packet must be received in writing in the Purchasing Division, **NO LATER THAN TEN CALENDAR DAYS PRIOR TO THE BID CLOSING DATE TO ENSURE AN ANSWER IS PROVIDED PRIOR TO CLOSING.**

Direct all questions to:

Greg Givens, Acting Purchasing Manager
City of Naples, Purchasing Division
735 8th Street South
Naples, Florida 34102
PH: (239) 213-7100 FX: (239) 213-7105
ggivens@naplesgov.com

**Solid Waste Refuse Containers
(Annual Contract)
SPECIFICATIONS**

1. Purpose

The purpose of this bid is to establish an annual contract for the purchases of front-loading refuse containers for the City of Naples Solid Waste Division, Naples, Florida, beginning approximately April 30, 2013.

2. Bid Prices

Prices quoted shall be exclusive of any taxes. Shipping charges shall be included in the unit prices provided.

3. Delivery

Bid prices will include delivery to the City of Naples, Solid Waste Division located at 50 Riverside Circle, Naples, Florida 34102.

4. Award

Bid will be awarded on an "all or nothing" basis or item-by-item, whichever is in the best interest of the City.

5. Minimum Orders

Orders will be placed periodically based upon City requirements. Bidders shall state their minimum order(s) on the bid schedule.

6. Bid Exceptions

Any exceptions to the specifications, general or special conditions, must be clearly noted on a separate sheet of paper and included with your bid proposal.

7. Estimated Quantities

Approximately 130 containers will be purchased of various sizes.

SPECIFICATIONS

The following are minimum specification intended to provide the information necessary for bidders to submit proposals to the City of Naples for the following:

FRONT LOADING CONTAINERS WITH DURAFLEX LIDS (OR EQUIVALENT)

1. Steel Containers

- A. All welds will conform to the America Welding Society's (AWS) standards and be free of slag. All interior welds will be free of splatter and sharp edges. Workmanship, welding, cutting, fabrication, and assembly will be of high quality and in conformance with good manufacturing practices.
- B. Bottom of containers must have THREE (3) 1-gauge capped skids, front to rear to continue 3" up front and rear of can.
- C. Bottoms must be constructed of 10-gauge steel.
- D. Sides must be constructed of 12-gauge steel.
- E. Bottom and inside of container shall be continuously welded and watertight. There shall be no spot welds anywhere within the container.
- F. Drain plug shall be 1 ½ inches in diameter and be fabricated on the backside of container; the right lower corner opposite side of pick-up wall.
- G. Perimeter to be capped with 3 inch, angle structural steel not less than 11-gauge.
- H. Pick up sleeves fabricated from a minimum of 7-gauge steel, 8" x 34" for 4 yd³ to 8 yd³ containers; 8" x 24" for 2 yd³ shall be continuously welded to the container, shall have six (6) or more gussets, three (3) top and three (3) bottom. Three sided one-piece guide to help fork into the sleeve (also called Blunderbuss)
- I. Bumper plates to be wrap-around type, minimum 7-gauge steel, size 7" x 15".
- J. Corners: lap joints, triple strength corners front and back
- K. Top lids, split type on all can (Duraflex or equivalent) unconditionally guaranteed against all manufactures' defects which could cause cracking or

breaking in normal use for (2) years. Lids that have been modified, cut from a roll, or do not appear to be a factory fit to the container shall not be accepted. Side doors must dirt snug but not wedge.

- L. All rust and mill scale must be removed by sandblasting or power tools, cleaned to remove oil and grease.
- M. For painted containers:
Zinc chromate, or equivalent, shall be applied to the entire interior and exterior (100%) of the container. Finish coats shall be applied to the entire interior and exterior of the container. There shall be two (2) finish coats of forest green enamel applied to the entire container. All primer and finish coats shall be applied after all fabrication has been completed. Paint color must be confirmed and approved by the CITY.
- N. Quotations are requested of 2, 4, 6, and 8 yd³ containers.
- O. No slants on 2 yd³ containers.
- P. All 2 and 4 yd³ steel and plastic containers shall have caster plates and mounting plate for wheels.
- Q. Plastic containers shall have molded sleeves.

2. Plastic Containers

Bidders of plastic containers will provide their technical specification with the bid proposal. The CITY reserves the right to accept the bid that is considered the lowest and most advantageous.

3. Dumpster Lid Manufacturer

Duraflex is a manufacturer of dumpster lids. All lids being provided shall be Duraflex or an approved equal. Bidders offering an alternate bid must include documentation proving that submitted products are an equal product to Duraflex, and must be approved by the Contract Administrator.

4. Rejection of Bids

The CITY reserves the rights to reject any or all containers that do not meet bid specifications or are otherwise authorized by the Solid Waste Division.

BIDSCHEDULEI

STEELCONTAINERS

| <u>ITEM</u> | <u>UNITCOST</u> |
|----------------------------------|------------------|
| 1. 8 yd ³ Containers | |
| A. Plastic side doors, flat top | \$ <u>749.95</u> |
| B. Steel side doors, flat top | \$ <u>744.95</u> |
| C. Plastic side doors, slant top | \$ <u>734.95</u> |
| D. Steel side doors, slant top | \$ <u>734.95</u> |
| 2. 6 yd ³ Containers | |
| A. Plastic side doors, flat top | \$ <u>629.95</u> |
| B. Steel side doors, flat top | \$ <u>624.95</u> |
| C. Plastic side doors, slant top | \$ <u>629.95</u> |
| D. Steel side doors, slant top | \$ <u>624.95</u> |
| 3. 4 yd ³ Containers | |
| A. Plastic side doors, flat top | \$ <u>519.95</u> |
| B. Steel side doors, flat top | \$ <u>514.95</u> |
| 4. 2 yd ³ Containers | |
| A. Flat top-no casters | \$ <u>324.95</u> |

State Minimum Order: truck load quantities

Delivery can be accomplished within 21 calendar days after receipt of Purchase Order.

Prompt Pay Terms: N/A% Days

BIDSCHEDULEII
PLASTICCONTAINERS

| <u>ITEM</u> | <u>UNITCOST</u> |
|---------------------------------|-----------------|
| 1. 4 yd ³ Containers | |
| A. No casters | \$ <u>N/A</u> |
| B. With Casters | \$ <u>N/A</u> |
| 2. 2 yd ³ Containers | |
| A. No casters | \$ <u>N/A</u> |
| B. With casters | \$ <u>N/A</u> |

State Minimum Order: _____

Delivery can be accomplished within _____
Order.

Prompt Pay Terms: _____% _____ Days

|

SUBMISSION CHECKLIST

Bidder should check off each of the following items as the necessary action is completed:

| CHECKLIST ELEMENTS | INCLUDED |
|---|----------|
| <ul style="list-style-type: none"> Submit one (1) original signature and one (1) copy of to your original bid proposal / document. | YES |
| <ul style="list-style-type: none"> Include any required drawings; descriptive literature; qualifications; schedules; product compliance / exceptions; alternatives; questionnaire; references, pricing/cost; and any information required of the proposer identified in the text of the bid. | YES |
| <ul style="list-style-type: none"> Include any delivery information. | YES |
| <ul style="list-style-type: none"> Complete and include this form with your bid document. Do not forget to have an authorized individual sign in the appropriate pages. | YES |
| <ul style="list-style-type: none"> Be sure the bid proposal / document has been signed in original on the <u>Cover Sheet</u> page with any bid addendums initialed. | YES |
| <p style="text-align: center;">The mailing envelope has been addressed to: City of Naples Purchasing Division 735 8th Street South Naples, Florida 34102</p> | YES |
| <p style="text-align: center;">The mailing envelope should be sealed and marked with: BID Number BID Title Closing Date</p> | YES |

ALL COURIER DELIVERED PROPOSALS SHOULD HAVE THE ITB NUMBER AND TITLE ON THE OUTSIDE OF THE COURIER PACKET.

**CITY OF NAPLES
PURCHASING DIVISION
CITY HALL, 735 8TH STREET SOUTH
NAPLES, FLORIDA 34102
PH: 239-213-7100 FX: 239-213-7105**

ADDENDUM NUMBER 1

| NOTIFICATION DATE: | BID TITLE: | BID NUMBER: | BID OPENING DATE & TIME: NEW |
|-----------------------|--------------------------------------|---------------|---------------------------------|
| 02/05/13 | Solid Waste Refuse Containers | 021-13 | 02/22/13 2:00PM |

**THE FOLLOWING INFORMATION IS HEREBY INCORPORATED INTO,
AND MADE AN OFFICIAL PART OF THE ABOVE REFERENCED BID.**

A non-mandatory pre-bid meeting has been added to this Bid. The pre-bid meeting will be held at 10:00 AM local time on Tuesday, February 12, 2013. The location of the meeting will be the Utilities Administration Building, 380 Riverside Circle, Naples FL 34102.

The sealed Bid opening date has also been changed. The Bid opening will be on February 22, 2013 at 2:00 PM at the City of Naples Purchasing Division.

IMPORTANT MESSAGE

PLEASE ACKNOWLEDGE RECEIPT OF THIS ADDENDUM ON THE BID COVER SHEET.

**CITY OF NAPLES
PURCHASING DIVISION
CITY HALL, 735 8TH STREET SOUTH
NAPLES, FLORIDA 34102
PH: 239-213-7100 FX: 239-213-7105**

ADDENDUM NUMBER 2

| NOTIFICATION DATE: | BID TITLE: | BID NUMBER: | BID OPENING DATE & TIME: |
|--------------------|-------------------------------|-------------|--------------------------|
| 02/12/13 | Solid Waste Refuse Containers | 021-13 | 02/22/13 2:00PM |

THE FOLLOWING INFORMATION IS HEREBY INCORPORATED INTO,
AND MADE AN OFFICIAL PART OF THE ABOVE REFERENCED BID.

Below is a clarification of the bid document.

Question: Your specifications call for 3 skids. In the past the standard skids were only 1.5 inches high by 3 inches wide. Most current container specifications are for 2 skid, 4 inches wide and 3 inches high(same amount of steel as other) but the high skids keep the container out of water/ mud etc and allow to be hosed out underneath the container for varmint and litter control. This has been the preferred design. Is this set up acceptable?

Answer: Per the bid specs the City is requesting the containers to be built to the specifications as written. There shall be no alternatives with reducing the number of skids that shall be mounted to the bottom of the containers. The dimensions of the container skids shall be consistent with industry standards which are typically 4 inches wide by 3 inches tall

Below are example pictures of end product containers.

END OF MESSAGE

PLEASE ACKNOWLEDGE RECEIPT OF THIS ADDENDUM ON THE BID FORMS WHEN

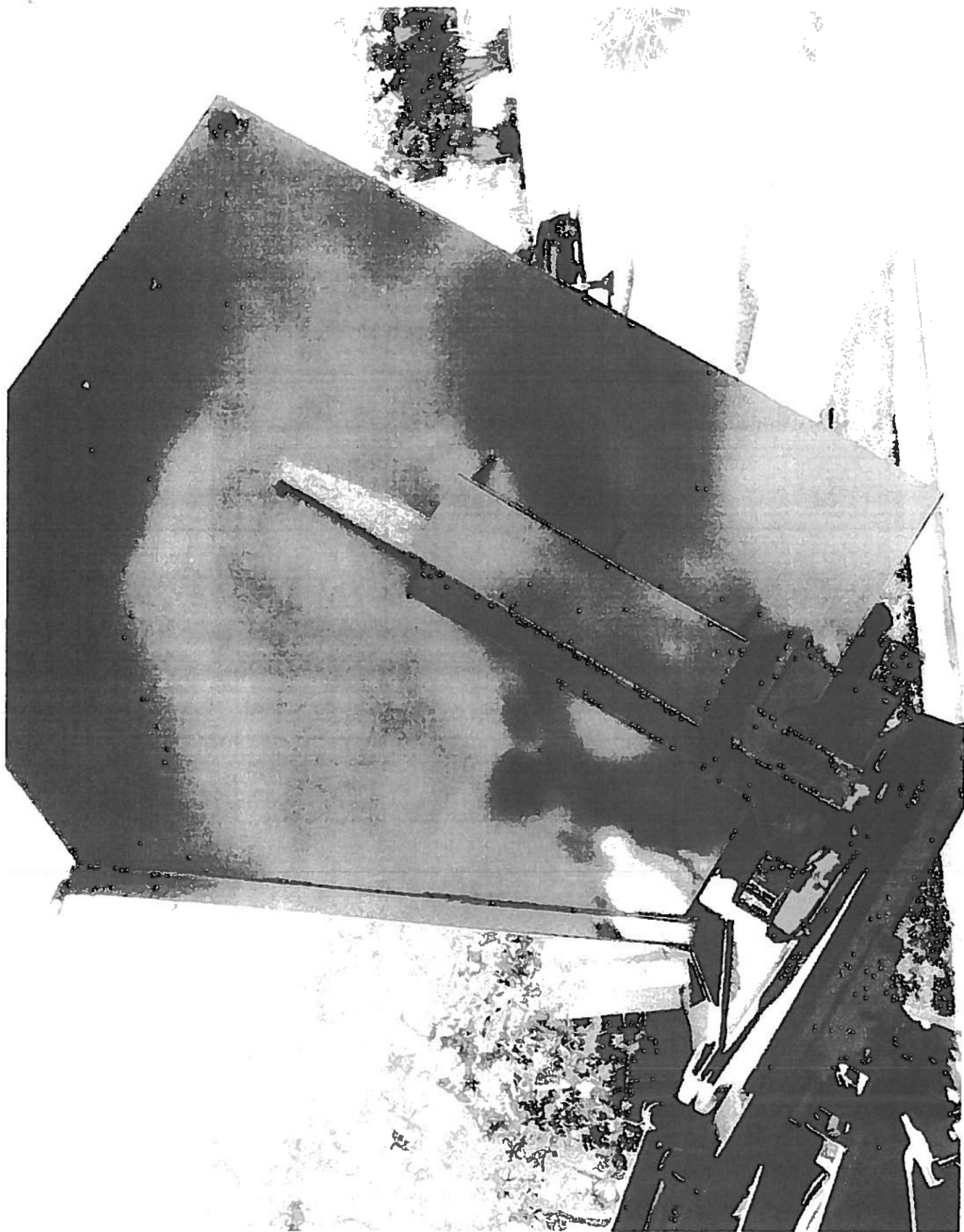

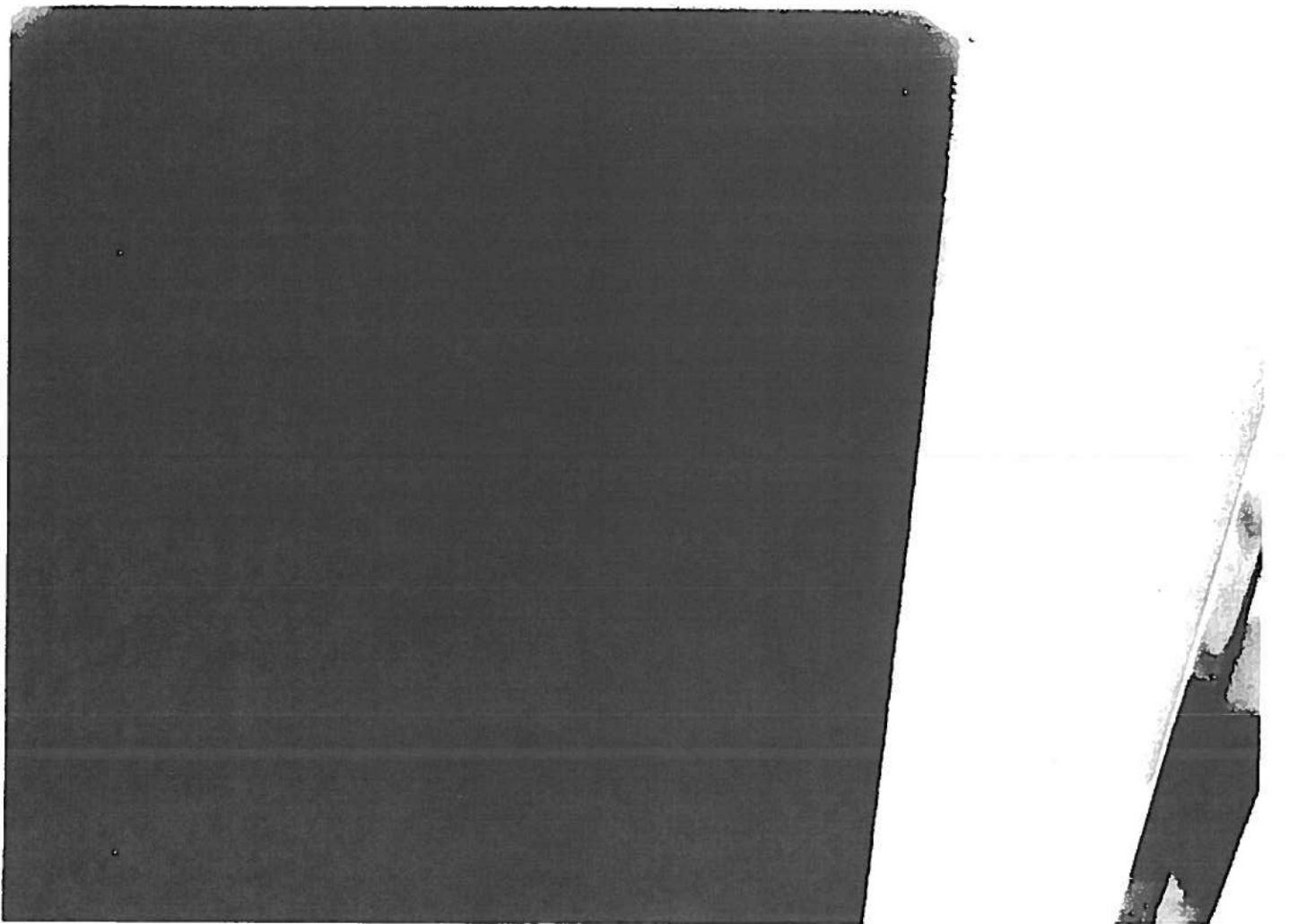
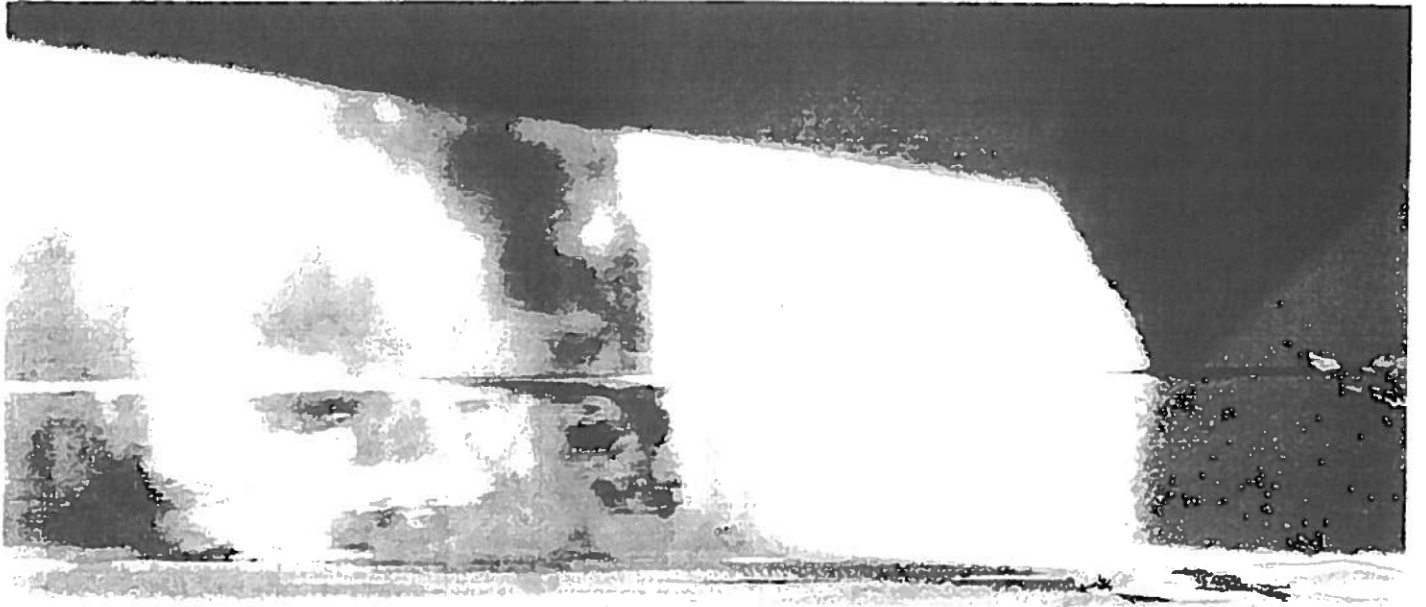



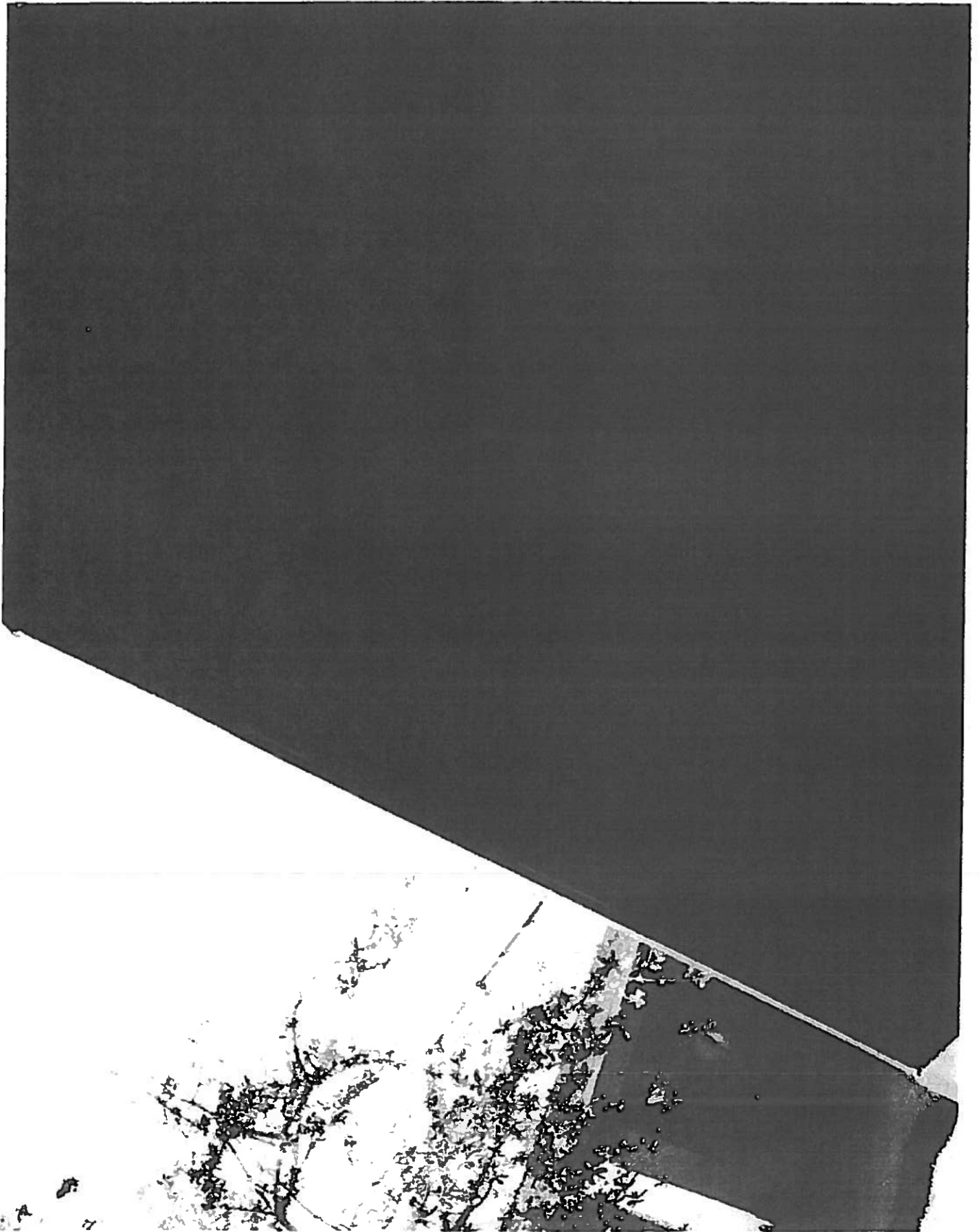

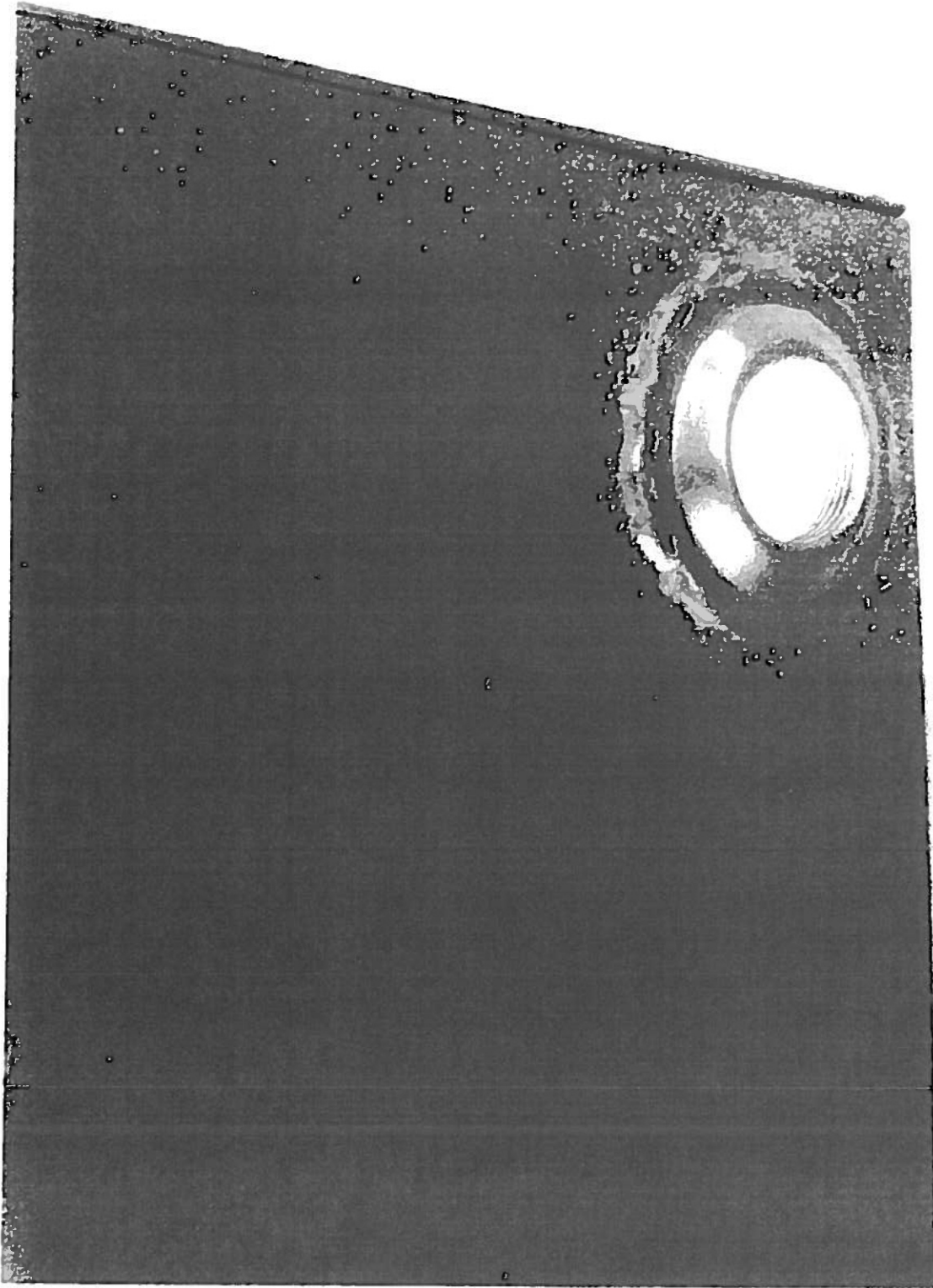

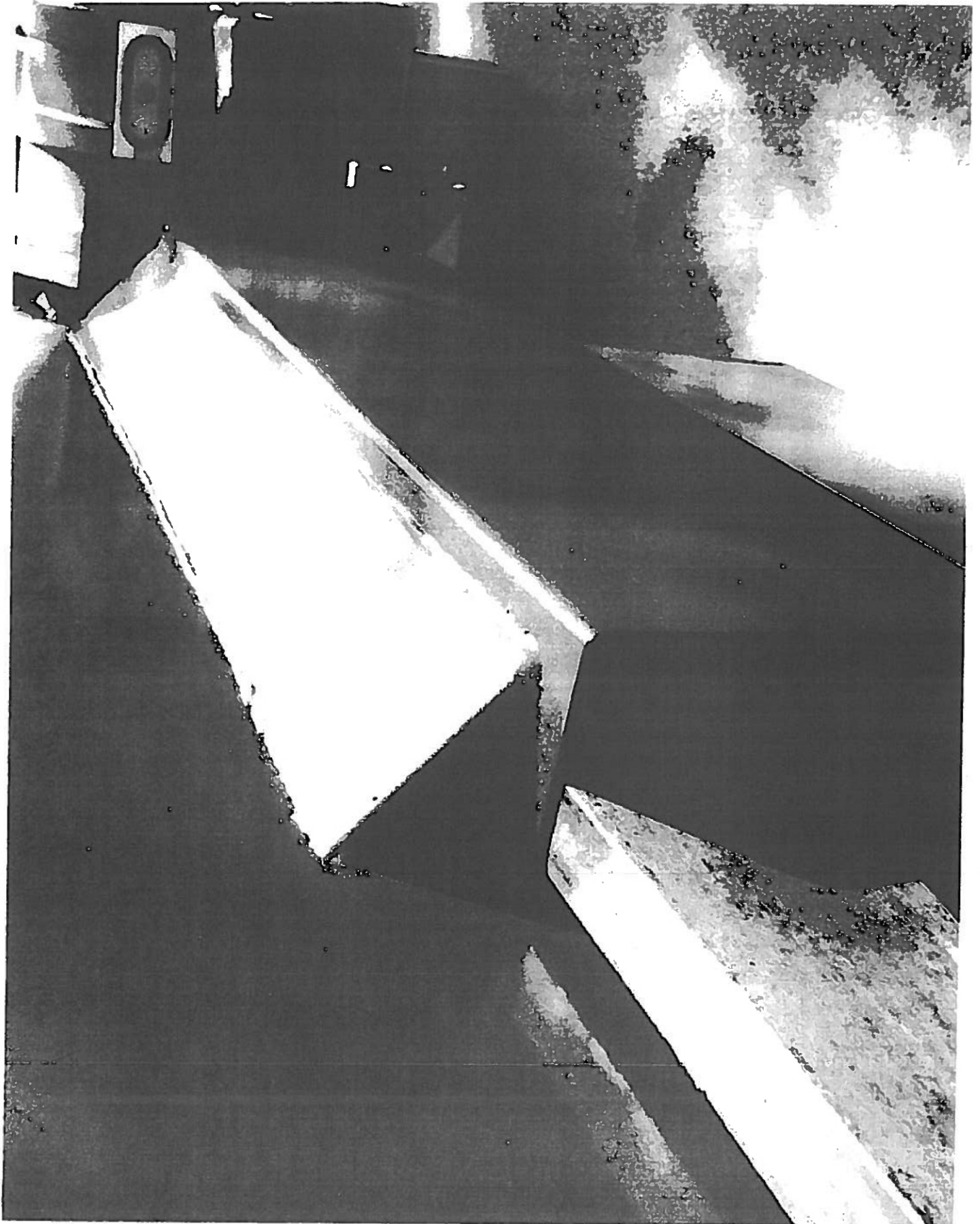



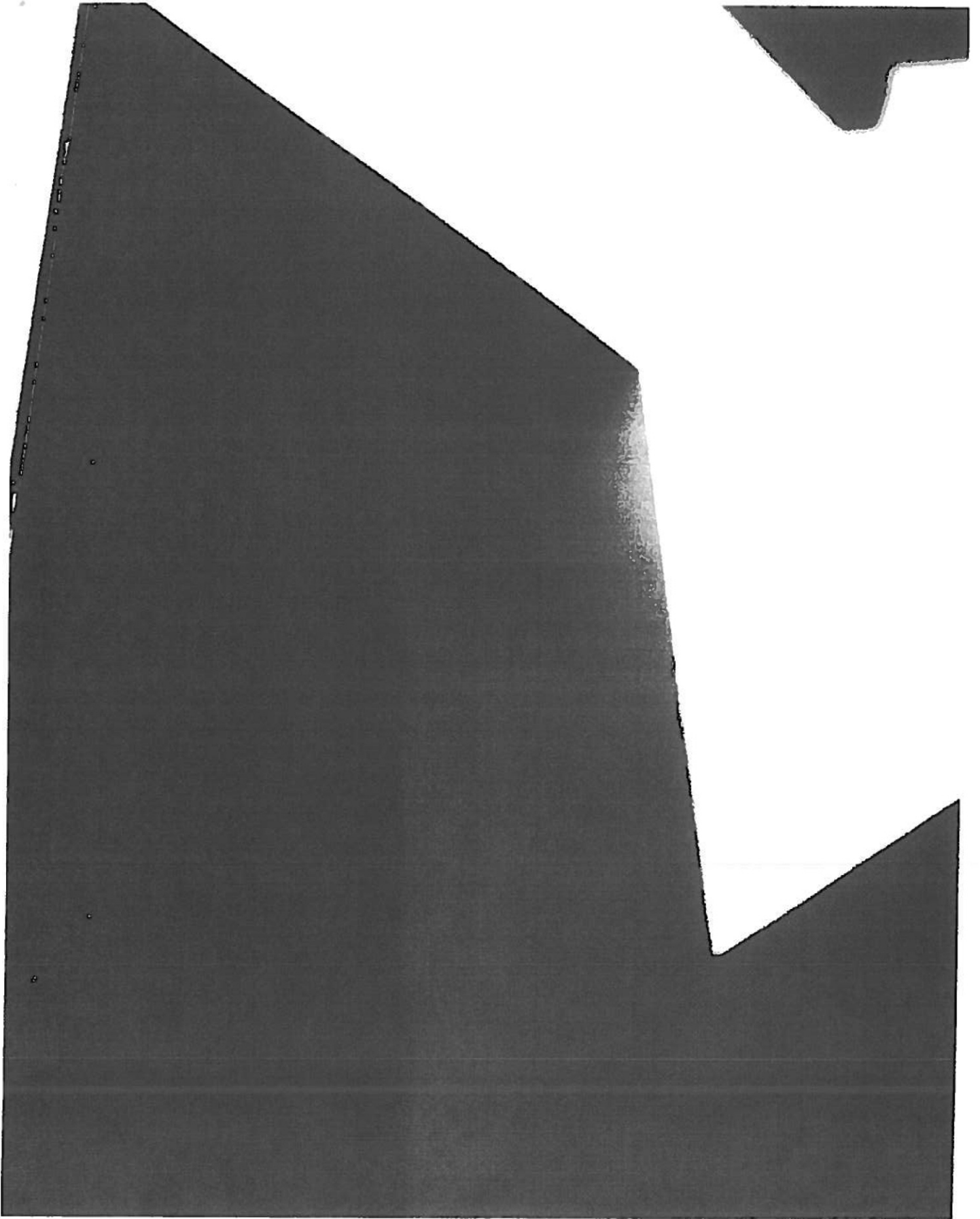

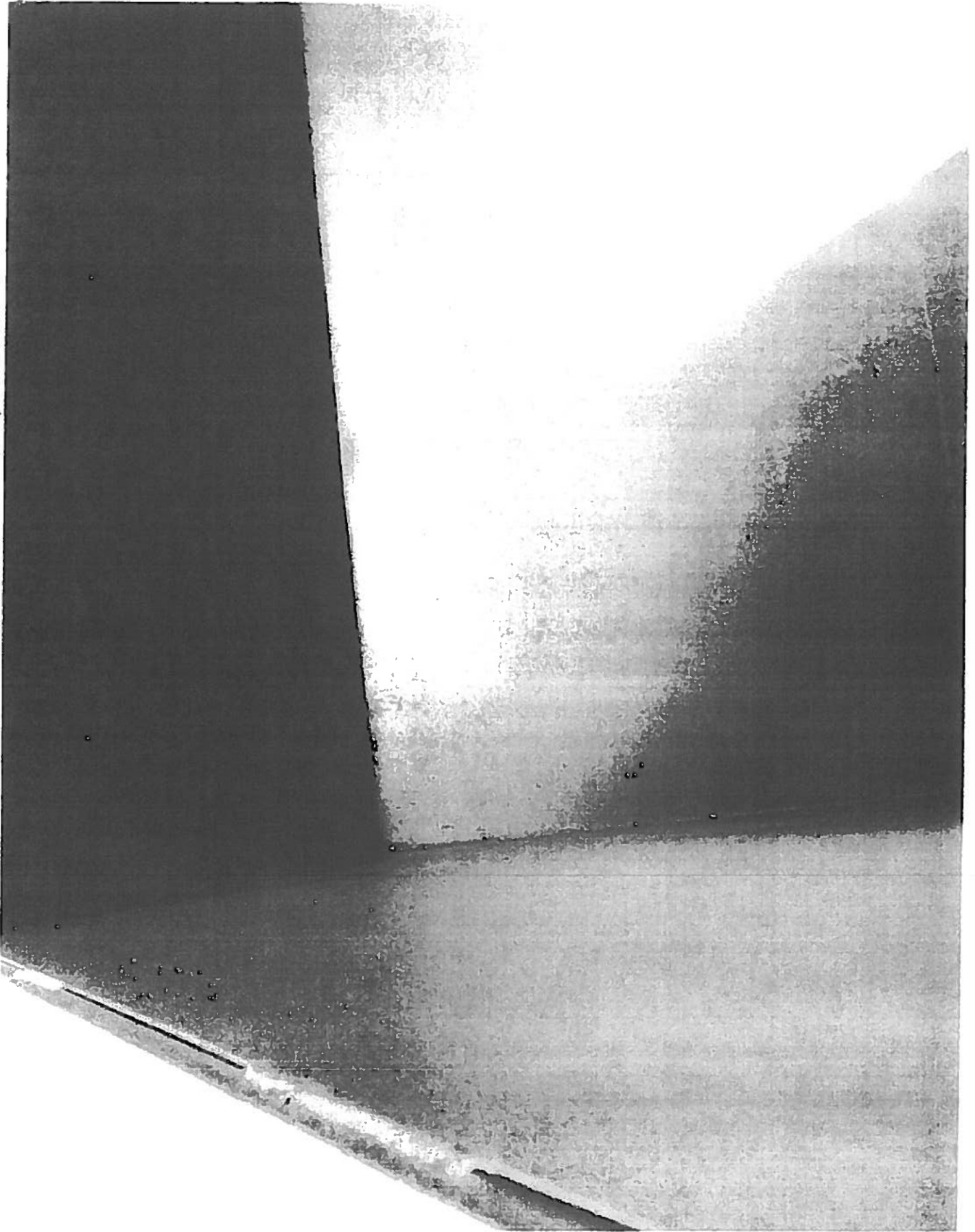



Front Loader Containers



Industrial Equipment Solutions

Office: 305-687-9400

Fax: 305-687-9700

Email: Recycleies@gmail.com



All of our containers are built to last. The major stress areas on our containers are all reinforced and fully welded on the inside for liquid retention and added strength. Every container is prepped, primed and painted with top quality coatings to endure the harsh elements. The quality continues through every aspect of construction and assembly to offer you the best product available.

Front Loader Containers

Built in Steel and or Aluminum

Upon request:

Features:

- All containers come with heavy duty plastic lids.
- All containers are vertically crimped where necessary for added rigidity.

1 Cubic Yard
(Square Type)

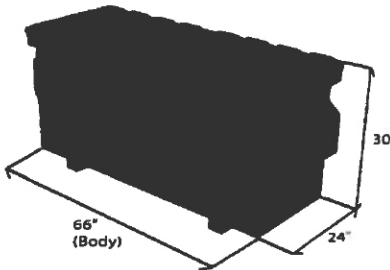

2 Cubic Yards
(Square Type)

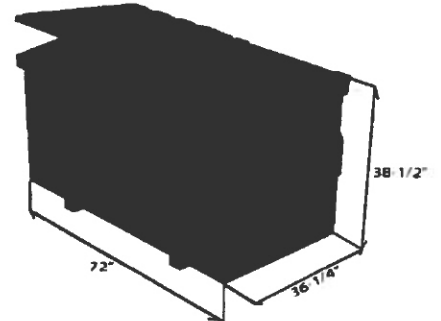

3 Cubic Yards

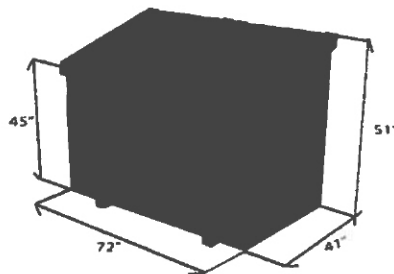

4 Cubic Yards

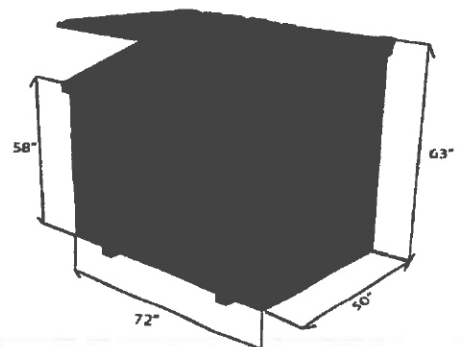

Custom Recycling Containers available:

- With slots to accept folded cartons and other recyclable material.
- Lid-lock for added security

8 Cubic Yards

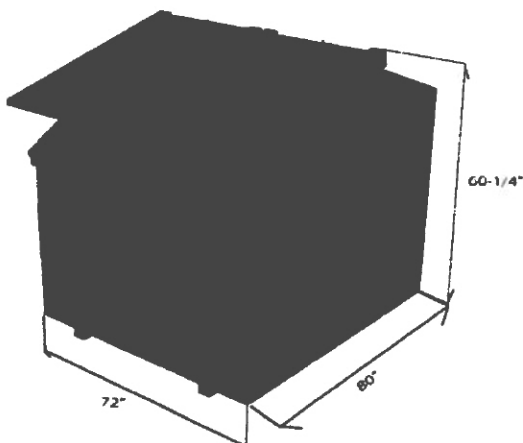

6 Cubic Yards

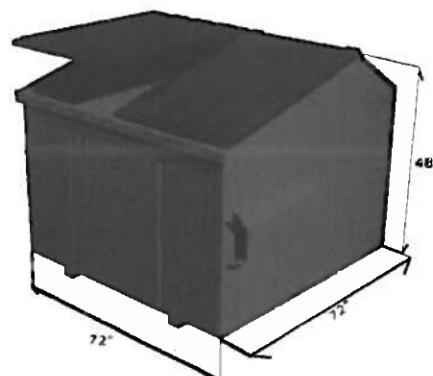

021-13 Solid Waste Containers

Exhibit B-1

| Bid Schedule I Steel Containers | | | | | | | | | |
|---------------------------------|------------------------------------|-----------------------|----------------------------|--------------------|-------------------|---------------------------|---------------|------------------|-----------|
| Item | Description | Rebig Pacific Company | Otto Environmental Systems | Nedland Industries | Iron Container | IES Sales and Service LLC | Wastequip Mfg | Nuwave Container | Unit Cost |
| 1 | 8yd³ Containers | | | | | | | | |
| | A. Plastic side doors, flat top | no bid | no bid | no bid | \$ 750.00 | \$ 749.95 | \$ 759.00 | no bid | |
| | B. Steel side doors, flat top | no bid | no bid | no bid | \$ 750.00 | \$ 744.95 | \$ 784.00 | no bid | |
| | C. Plastic side door, slant top | no bid | no bid | no bid | \$ 730.00 | \$ 739.95 | \$ 770.00 | no bid | |
| 2 | 6 yd³ Containers | | | | | | | | |
| | A. Plastic side doors, flat top | no bid | no bid | no bid | \$ 655.00 | \$ 629.29 | \$ 674.00 | no bid | |
| | B. Steel side doors, flat top | no bid | no bid | no bid | \$ 655.00 | \$ 624.95 | \$ 699.00 | no bid | |
| | C. Plastic side door, slant top | no bid | no bid | no bid | \$ 625.00 | \$ 629.95 | \$ 654.00 | no bid | |
| 3 | 4 yd³ Containers | | | | | | | | |
| | A. Plastic side doors, flat top | no bid | no bid | no bid | \$ 500.00 | \$ 519.95 | \$ 522.00 | no bid | |
| | B. Steel side doors, flat top | no bid | no bid | no bid | \$ 500.00 | \$ 514.95 | \$ 535.00 | no bid | |
| | D. Steel side doors, slant top | no bid | no bid | no bid | \$ 625.00 | \$ 624.95 | no bid | no bid | |
| 4 | 2 yd³ Containers | | | | | | | | |
| | a. Flat top-no caster | no bid | no bid | no bid | \$ 345.00 | \$ 324.95 | \$ 395.00 | no bid | |
| | State Minimum Order | none | none | none | None | Truckload | none | none | |
| | Delivery | N/A | N/A | N/A | 30 days | \$ 21.00 | 30 days | N/A | |
| | Notes | | | | No doors on Slant | | | | |